

Description

The 5.0SMDJ-TR series is designed specifically to protect sensitive electronic equipment from voltage transients induced by lightning and other transient voltage events.

Features

- I Optimized glass passivated chip
- I $T_j = 150\text{ }^\circ\text{C}$ capability suitable for high reliability and automotive requirement
- I 5000 W peak pulse power capability with a 10/1000 μs waveform, repetitive rate (duty cycle):0.01 %
- I Meet ISO 7637-2 load dump test (varied by test condition)
- I High reliability application and automotive grade AEC Q101 qualified
- I Low leakage
- I Uni and Bidirectional unit
- I Excellent clamping capability
- I Very fast response time
- I ROHS compliant
- I High Operating temperature & Reliability

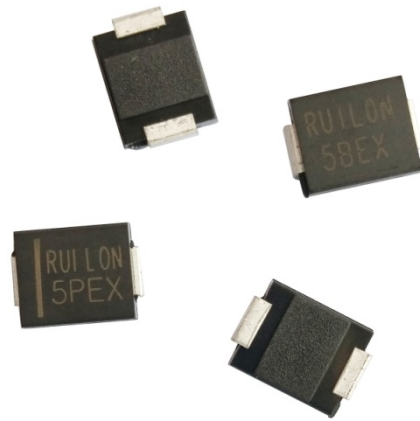

Mechanical Data

- I Case: Molded plastic
- I Epoxy: UL 94V-0 rate flame retardant
- I Lead: Solderable per MIL-STD-750, method 2026
- I Polarity: Color band denotes cathode end except Bipolar
- I Mounting position: Any

Part Number Code

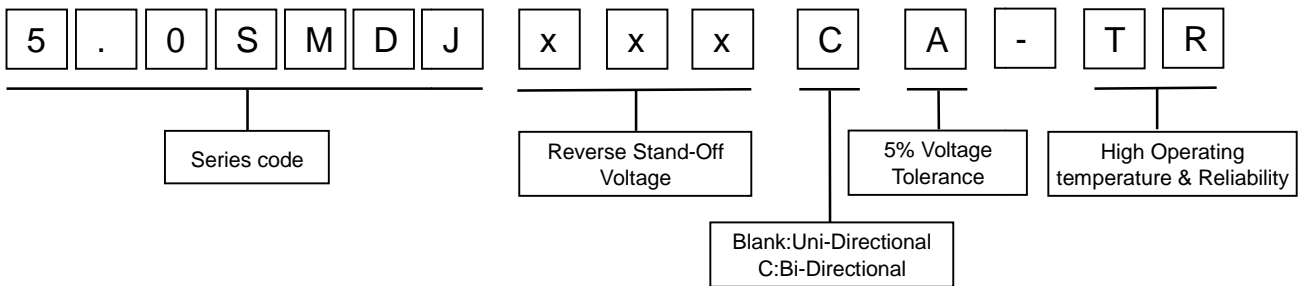

Mechanical Characteristics

Rating	Symbol	Value	Units
Peak power dissipation with a 10/1000 μs waveform ⁽¹⁾	P_{PP}	5000	W
Power Dissipation on Infinite Heat Sink at $T_L=50\text{ }^\circ\text{C}$	P_D	6.5	W
Peak forward surge current, 8.3 ms single half sine-wave unidirectional only ⁽²⁾	I_{FSM}	300	A
Operating junction and Storage Temperature Range.	T_J, T_{STG}	-55 to 150	$^\circ\text{C}$

1. Non-repetitive current pulse per Fig.5 and derated above $T_A=25\text{ }^\circ\text{C}$ per Fig. 1.
 2. Measured on 8.3 ms single half sine-wave or equivalent square wave, duty cycle = 4 pulses per minute maximum



Electrical Characteristics

Type Number		Marking		Working Peak Reverse Voltage	Breakdown Voltage		Test Current	Max. Clamping Voltage	Max. Peak Pulse Current	Max. Reverse Leakage
					$V_{BR} @ I_T$					
					V_R					
UNI	BI	UNI	BI	V	Min	Max	mA	V	A	μA
5.0SMDJ10A-TR	5.0SMDJ10CA-TR	5SAE	5DAE	10.0	11.10	12.30	1	17.0	294.12	5
5.0SMDJ11A-TR	5.0SMDJ11CA-TR	5SAF	5DAF	11.0	12.20	13.50	1	18.2	274.73	2
5.0SMDJ12A-TR	5.0SMDJ12CA-TR	5SAG	5DAG	12.0	13.30	14.70	1	19.9	251.26	2
5.0SMDJ13A-TR	5.0SMDJ13CA-TR	5SAK	5DAK	13.0	14.40	15.90	1	21.5	232.56	2
5.0SMDJ14A-TR	5.0SMDJ14CA-TR	5SAM	5DAM	14.0	15.60	17.20	1	23.2	215.52	2
5.0SMDJ15A-TR	5.0SMDJ15CA-TR	5SAP	5DAP	15.0	16.70	18.50	1	24.4	204.92	2
5.0SMDJ16A-TR	5.0SMDJ16CA-TR	5SAR	5DAR	16.0	17.80	19.70	1	26.0	192.31	2
5.0SMDJ17A-TR	5.0SMDJ17CA-TR	5SAT	5DAT	17.0	18.90	20.90	1	27.6	181.16	2
5.0SMDJ18A-TR	5.0SMDJ18CA-TR	5SAV	5DAV	18.0	20.00	22.10	1	29.2	171.23	2
5.0SMDJ19A-TR	5.0SMDJ19CA-TR	5SAX	5DAX	19.0	21.10	23.30	1	30.8	162.44	2
5.0SMDJ20A-TR	5.0SMDJ20CA-TR	5SAZ	5DAZ	20.0	22.20	24.50	1	32.4	154.32	2
5.0SMDJ22A-TR	5.0SMDJ22CA-TR	5SBE	5DBE	22.0	24.40	26.90	1	35.5	140.85	2
5.0SMDJ24A-TR	5.0SMDJ24CA-TR	5SBF	5DBF	24.0	26.70	29.50	1	38.9	128.53	2
5.0SMDJ26A-TR	5.0SMDJ26CA-TR	5SBG	5DBG	26.0	28.90	31.90	1	42.1	118.76	2
5.0SMDJ28A-TR	5.0SMDJ28CA-TR	5SBK	5DBK	28.0	31.10	34.40	1	45.4	110.13	2
5.0SMDJ30A-TR	5.0SMDJ30CA-TR	5SBM	5DBM	30.0	33.30	36.80	1	48.4	103.31	2
5.0SMDJ33A-TR	5.0SMDJ33CA-TR	5SBP	5DBP	33.0	36.70	40.60	1	53.3	93.81	2
5.0SMDJ36A-TR	5.0SMDJ36CA-TR	5SBR	5DBR	36.0	40.00	44.20	1	58.1	86.06	2
5.0SMDJ40A-TR	5.0SMDJ40CA-TR	5SBT	5DBT	40.0	44.40	49.10	1	64.5	77.52	2
5.0SMDJ43A-TR	5.0SMDJ43CA-TR	5SBV	5DBV	43.0	47.80	52.80	1	69.4	72.05	2
5.0SMDJ45A-TR	5.0SMDJ45CA-TR	5SBX	5DBX	45.0	50.00	55.30	1	72.7	68.78	2
5.0SMDJ48A-TR	5.0SMDJ48CA-TR	5SBZ	5DBZ	48.0	53.30	58.90	1	77.4	64.60	2
5.0SMDJ51A-TR	5.0SMDJ51CA-TR	5SCE	5DCE	51.0	56.70	62.70	1	82.4	60.68	2
5.0SMDJ54A-TR	5.0SMDJ54CA-TR	5SCF	5DCF	54.0	60.00	66.30	1	87.1	57.41	2
5.0SMDJ58A-TR	5.0SMDJ58CA-TR	5SCG	5DCG	58.0	64.40	71.20	1	93.6	53.42	2

Note:

1. Add suffix 'C' or 'CA' after part number to specify Bi-directional devices
2. For Bi-Directional devices having VR of 10 volts, the IR limit is double



I-V Curve Characteristics

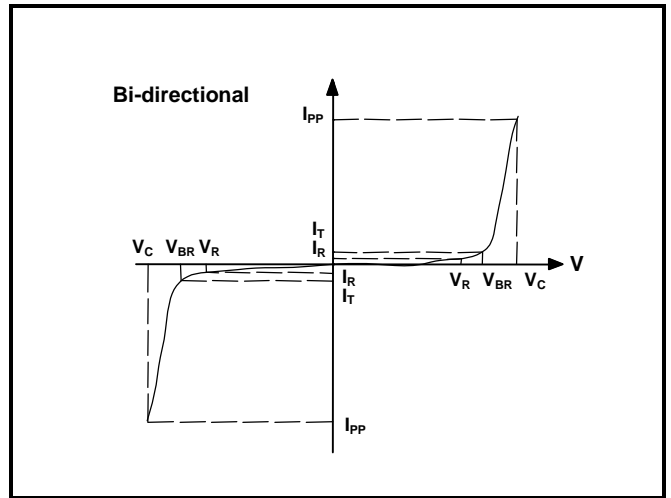
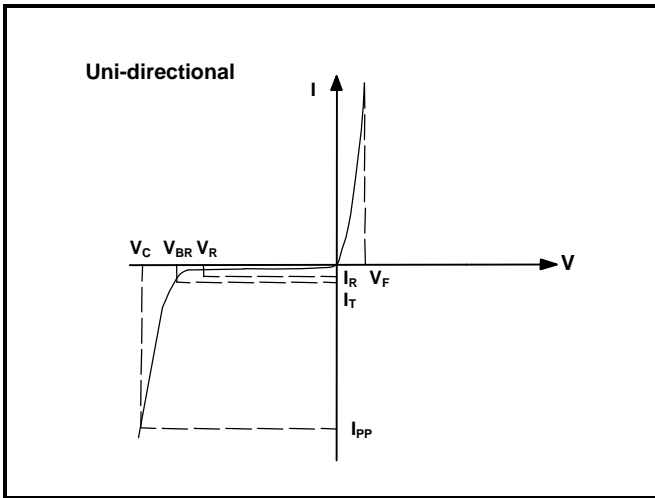

P_{PPM} Peak Pulse Power Dissipation -- Max power dissipation

V_R Stand-off Voltage -- Maximum voltage that can be applied to the TVS without operation

V_{BR} Breakdown Voltage -- Maximum voltage that flows though the TVS at a specified test current (I_T)

V_C Clamping Voltage -- Peak voltage measured across the TVS at a specified I_{ppm} (peak impulse current)

I_R Reverse Leakage Current -- Current measured at V_R

V_F Forward Voltage Drop for Uni-directional

Ratings and Characteristic Curves ($T_A=25^\circ\text{C}$ unless otherwise noted)

Figure 1 - Pulse Derating Curve

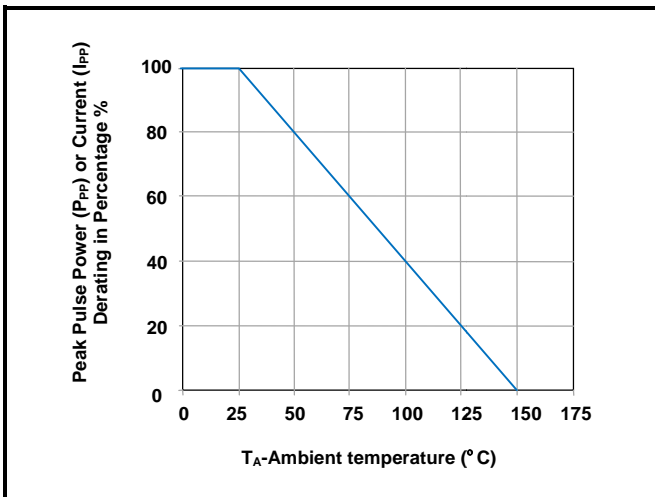

Figure 2 - Maximum Non-Repetitive Surge Current

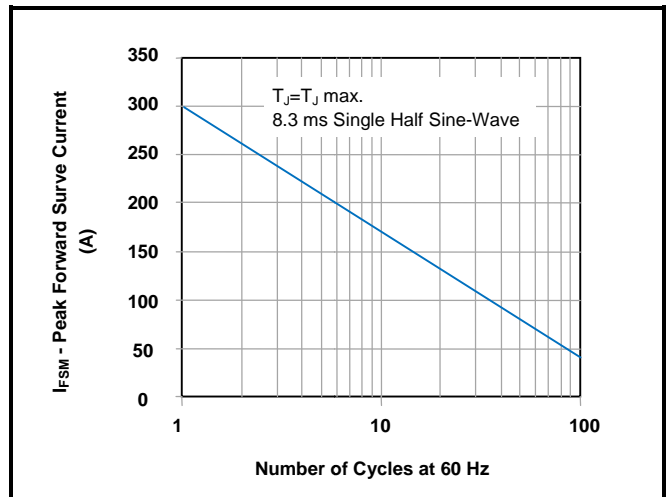

Figure 3 - Steady State Power Derating Curve

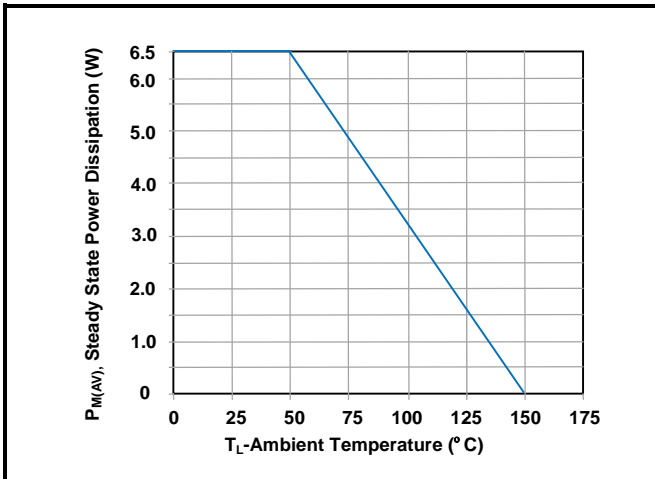

Figure 4 - Peak Pulse Power Rating Curve

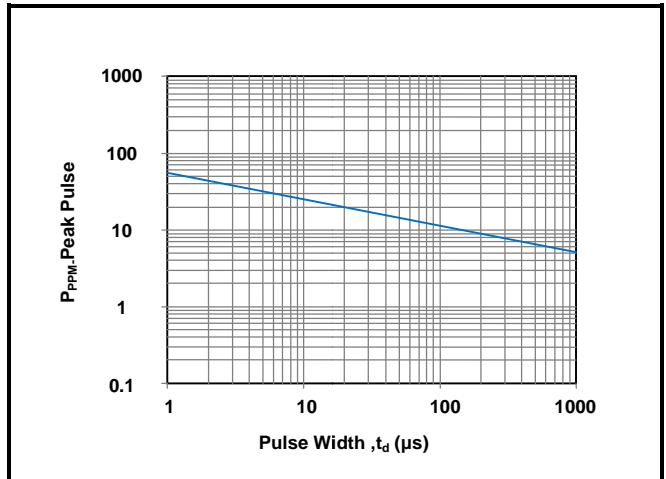

Figure 5 - Pulse Waveform

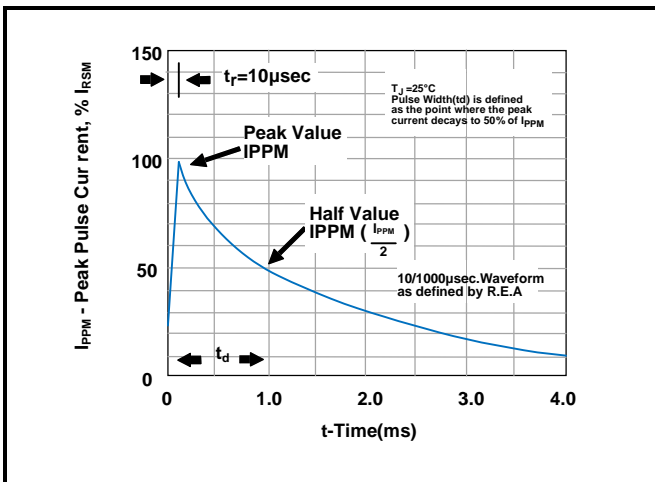
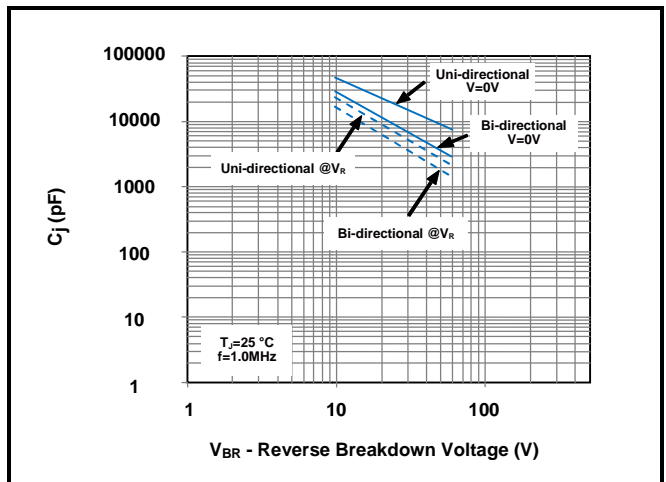
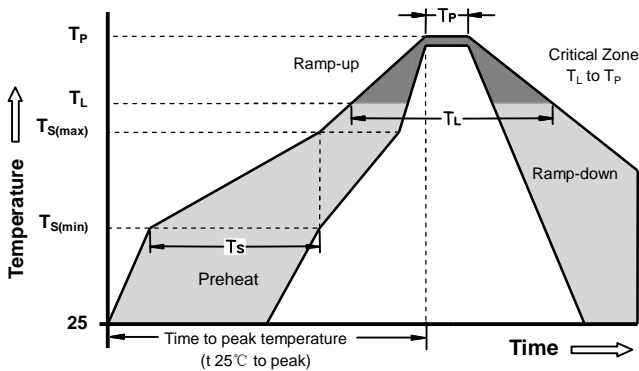

Figure 6 - Typical Junction Capacitance



Soldering Parameters - Reflow Soldering (Surface Mount Devices)



Reflow Condition		Pb - Free assembly
Pre Heat	-Temperature Min ($T_{S(min)}$)	150°C
	-Temperature Max ($T_{S(max)}$)	200°C
	- Time (min to max) (t_s)	60 -180 Seconds
Average ramp up rate (Liquids Temp T_L) to peak		3°C/second max
$T_{S(max)}$ to T_L - Ramp-up Rate		3°C/second max
Reflow	- Temperature (T_L) (Liquids)	217°C
	- Time (min to max) (t_s)	60 -150 Seconds
Peak Temperature (T_P)		260 +0/-5°C
Time within 5°C of actual peak Temperature (t_p)		20 - 40 Seconds
Ramp-down Rate		6°C/second max
Time 25°C to peak Temperature (T_P)		8 minutes Max
Do not exceed		260°C



Part Marking System

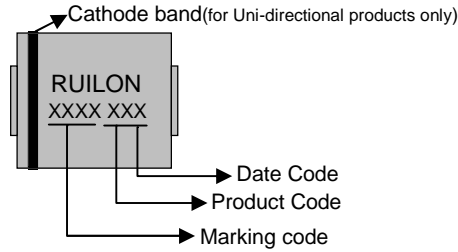

Dimensions

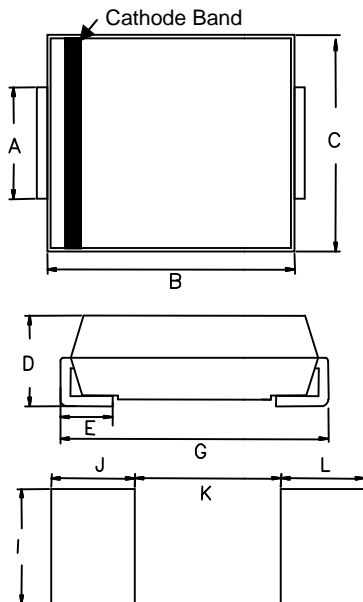

DIM	Millimeters		Inches	
	Min	Max	Min	Max
A	2.90	3.20	0.114	0.126
B	6.60	7.15	0.260	0.281
C	5.55	6.04	0.219	0.238
D	1.98	2.53	0.078	0.10
E	0.75	1.51	0.030	0.059
G	7.75	7.95	0.305	0.313
I	3.30	-	0.129	-
J	2.40	-	0.094	-
K	-	4.20	-	0.165
L	2.40	-	0.094	-



Taping and Reel Specifications

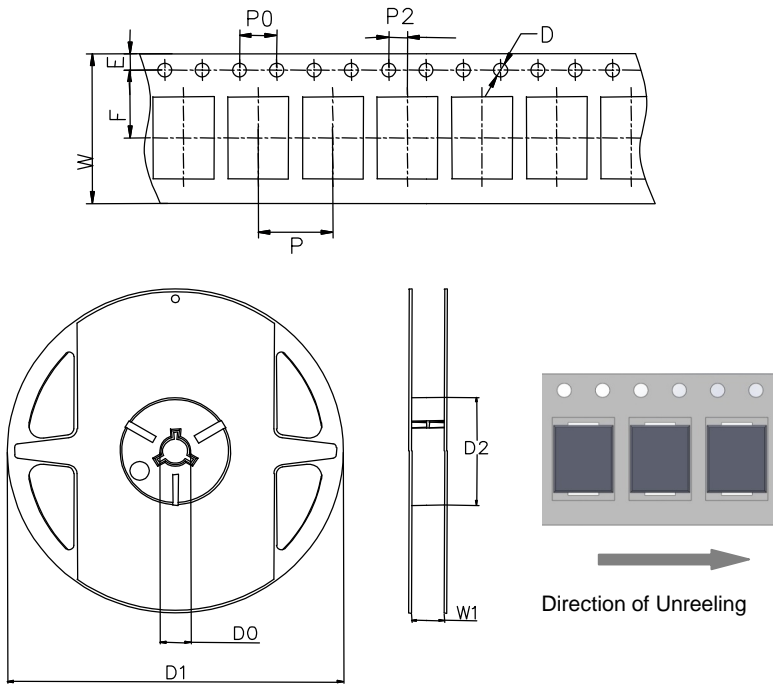

Symbol	Millimeters	Inches
W	16±0.3	0.630±0.012
P	8±0.1	0.315±0.004
F	7.25±0.1	0.285±0.004
E	1.75±0.1	0.069±0.004
D	1.5+0.1/-0.0	0.059+0.004/-0.0
P0	4±0.1	0.157±0.004
P2	2±0.1	0.079±0.004
D0	16.7±0.15	0.657±0.006
D1	178±2	7.007±0.079
D2	59.6+1/-2	2.346+0.039/-0.079
W1	17.2±0.4	0.677±0.016

Part Number	Component package	Quantity	Packaging option	Packaging specification
5.0SMDJXXXA/CA-TR	DO-214AB(SMC)	500	Tape&Reel-16mm/7"tape	EIA STD RS-481

